

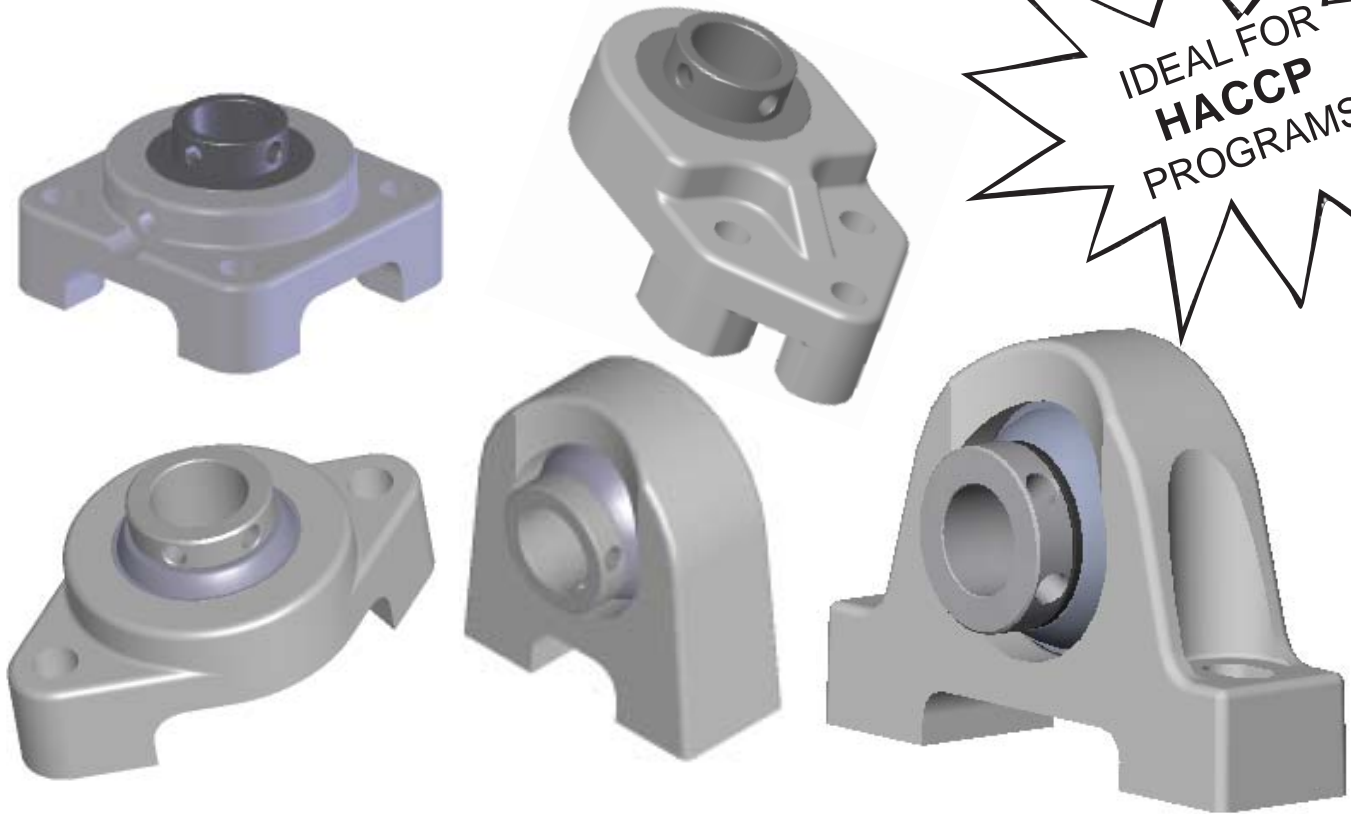

QuiKlean[®] STAND-OFF BEARINGS



Mounted bearings with integral stand-offs:

- 1-piece, solid polymer construction
- Smoothest surfaces, fewest crevices, easy to clean
- 5/8" stand-off for maximum cleanability
- Reduce downtime from sanitary violations
- No small components to handle or misplace
- Use with all brands of insert bearings

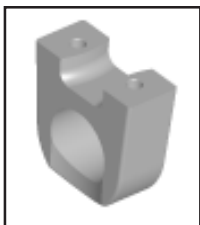

TWO- & FOUR- BOLT FLANGED POLY-ROUND® SOLUTION® QuiKlean® ASSEMBLIES



MOUNTED SET P/N		Shaft Diameter		A	B	C	D	E	Bolt Size	Wt in lbs.
				4-BOLTS ONLY						
GROUP	RING	mm	in	in mm	in mm	in mm	in mm	in mm		
B	204	12	1/2	3-17/32 89.7	2-1/2 63.5	1-1/16 26.9	1-7/32 30.7	2-13/64 56.0	3/8	
		15	9/16							
		17	5/8							
		19	11/16							
		20	3/4 13/16							
C	205	25	13/16	3-57/64 98.8	2-3/4 69.9	1-1/8 28.6	1-5/8 41.3	2-19/32 59.1	3/8	.6 .7
			7/8							
			15/16							
			1							
D	206	30	1	4-19/32 116.7	3-1/4 82.6	1-1/8 28.6	1-11/16 42.8	2-21/64 65.8	7/16	
			1-1/16							
			1-1/8							
			1-3/16							
			1-1/4							
E	207	35	1-3/16	5-1/8 130.2	3-5/8 92.1	1-3/16 30.1	1-27/32 46.8	2-15/16 74.6	7/16	
			1-1/4							
			1-5/16							
			1-3/8							
			1-7/16							
F	208	40	1-7/16	5-21/32 142.1	4 101.6	1-3/16 30.1	1-7/8 47.6	3-1/32 77.4	1/2	
			1-1/2							
			1-9/16							
			1-5/8							

For optional bearing materials see page H-3 (WHITE)

TWO- & FOUR- BOLT FLANGED STAINLESS BALL SOLUTION® QuiKlean® ASSEMBLIES

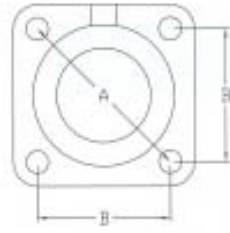
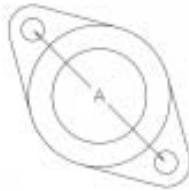

Poly-Round®

Ball bearing

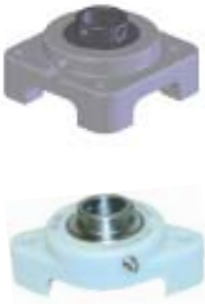

MOUNTED SET P/N		Shaft Diameter		A	B	C	D	F	Bolt Size	Wt in lbs.
				4-BOLTS ONLY						
GROUP	RING	mm	in	in mm	in mm	in mm	in mm	in mm		
B	204	12	1/2	3-17/32 89.7	2-1/2 63.5	1-1/16 26.9	1-7/32 30.7	1-15/16 49.2	3/8	
		15	9/16							
		17	5/8							
		19	11/16							
		20	3/4 13/16							
C	205	25	13/16	3-57/64 98.8	2-3/4 69.9	1-1/8 28.6	1-5/8 41.3	2-1/16 52.4	3/8	.4 .5
			7/8							
			15/16							
			1							
D	206	30	1	4-19/32 116.7	3-1/4 82.6	1-1/8 28.6	1-11/16 42.8	2-11/64 55.1	7/16	
			1-1/16							
			1-1/8							
			1-3/16							
			1-1/4							
E	207	35	1-3/16	5-1/8 130.2	3-5/8 92.1	1-3/16 30.1	1-27/32 46.8	2-29/64 62.3	7/16	
			1-1/4							
			1-5/16							
			1-3/8							
			1-7/16							
F	208	40	1-7/16	5-21/32 142.1	4 101.6	1-3/16 30.1	1-7/8 47.6	2-21/32 67.5	3/8	
			1-1/2							
			1-9/16							
			1-5/8							

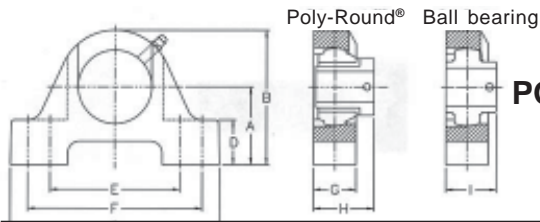

**PILLOW BLOCK
POLY-ROUND® & STAINLESS BALL SOLUTION®
QuiKlean® ASSEMBLIES**



MOUNTED SET P/N		Shaft Diameter		A	B	C	D	E	F	G	H	I	Bolt Size	Wt in lbs.
GROUP	RING	mm	in	in mm	in mm	in mm	in mm	in mm	in mm	in mm	in mm	in mm		
NA1GB-QK7- ZY1GB-QK8- B	204	12	1/2	1-15/16 49.2	3-5/16 84.1	5-1/4 133.4	1-1/8 28.5	3-1/4 82.6	4-3/8 111.1	1-3/8 34.9	1-39/64 40.8	1-15/64 31.3	3/8	
		15	9/16											
		17	5/8											
		20	11/16 3/4 13/16											
NA1GC-QK7- ZY1GC-QK8- C	205	25	13/16	2-1/16 52.4	3-9/16 90.5	5-1/2 139.7	1-3/16 30.1	3-7/16 87.3	4-5/8 117.5	1-1/2 38.1	1-43/64 42.4	1-11/32 34.1	3/8	.8 .9
			7/8											
			15/16 1											
NA1GD-QK7- ZY1GD-QK8- D	206	30	1	2-5/16 58.7	4 101.6	6-1/4 58.7	1-5/16 33.3	4-1/8 104.8	5-1/8 130.2	1-3/4 44.5	1-61/64 49.6	1-1/2 58.1	1/2	
			1-1/16											
			1-1/8											
			1-3/16 1-1/4											
NA1GE-QK7- ZY1GE-QK8- E	207	35	1-3/16	2-1/2 63.5	4-1/2 114.3	6-9/16 166.7	1-5/16 33.3	4-11/16 119.1	5-7/16 138.1	1-3/4 44.5	1-63/64 50.4	1-11/16 42.8	1/2	1.4 1.5
			1-1/4											
			1-5/16											
			1-3/8 1-7/16											
NA1GF-QK7- ZY1GF-QK8- F	208	40	1-7/16	2-3/4 69.9	4-15/16 125.4	7-1/4 184.2	1-3/8 34.9	5 127.0	6-1/8 155.6	1-15/16 49.2	2-35/64 64.7	1-59/64 48.8	1/2	
			1-1/2											
			1-9/16											
			1-5/8											

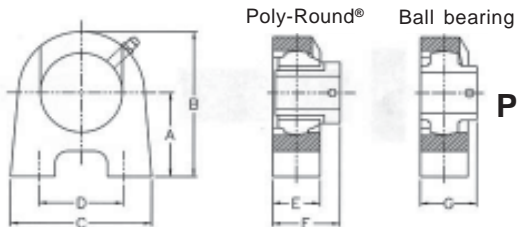

**TAPPED BASE PILLOW BLOCK
POLY-ROUND® & STAINLESS BALL SOLUTION®
QuiKlean® ASSEMBLIES**



MOUNTED SET P/N		Shaft Diameter		A	B	C	D	E	F	G	Bolt Size	Wt in lbs.
GROUP	RING	mm	in	in mm	in mm	in mm	in mm	in mm	in mm	in mm		
NA9GB-QK7- ZY9GB-QK8- B	204	12	1/2	1-15/16 49.2	3-1/4 82.6	3 76.2	2 50.8	1-7/16 36.5	1-45/64 43.3	1-15/64 31.4	3/8-16	
		15	9/16									
		17	5/8									
		20	11/16 3/4 13/16									
NA9GC-QK7- ZY9GC-QK8- C	205	25	13/16	2-1/16 52.4	2-9/16 65.1	3-1/4 82.6	2 50.8	1-7/16 36.5	1-49/64 44.8	1-11/32 34.1	3/8-16	
			7/8									
			15/16 1									
NA9GD-QK7- ZY9GD-QK8- D	206	30	1	2-5/16 58.7	4 101.6	4-1/4 108.0	3 76.2	1-5/8 41.3	2-7/64 53.6	1-1/2 38.1	7/16-14	
			1-1/16									
			1-1/8									
			1-3/16 1-1/4									
NA9GE-QK7- ZY9GE-QK8- E	207	35	1-3/16	2-1/2 63.5	4-1/2 114.3	4-1/2 114.3	3-1/4 82.6	1-3/4 44.5	2-23/64 59.9	1-1/2 38.1	1/2-13	
			1-1/4									
			1-5/16									
			1-3/8 1-7/16									
NA9GF-QK7- ZY9GF-QK8- F	208	40	1-7/16	2-9/16 65.1	4-3/4 120.7	4-3/4 120.7	3-1/2 88.9	1-7/8 47.6	2-1/2 63.5	1-15/16 49.2	1/2-13	
			1-1/2									
			1-9/16									
			1-5/8									



Why do QuiKlean® bearings stand above other food industry bearings?

QuiKlean® bearings dimensionally interchange with standard 2-bolt, 4-bolt, pillow block and tapped base housing with 5/8" additional space for cleaning

All components can be purchased individually for maximum flexibility, lower inventory and reduced replacement costs

Locking sleeve (316 stainless steel)

- controls lateral shaft movement
- protects shaft
- maximizes bearing life
- make damaged shafting usable
- can run on either side of Poly-Round® insert

EDT polymer housings are:

- strong
- reusable
- corrosion-resistant,
- have no coatings to chip or peel

Solid construction

- eliminates need for metal crush rings
- very sanitary
- very cleanable

Same load capacity as standard housings

Surface finishes demonstrated to be smoothest in industry

Choice of bearing materials for optimum performance in each installation

5/8" cleaning gap can help reduce sanitation downtime

Integrated stand-off

- facilitates HACCP compliance
- avoids small parts that can contaminate

QuiKlean® flange styles require shafts 1-1/4" longer than those using standard housings

EDT Corp

1006-J NE 146th Street

Vancouver, Washington 98685-1411

ph: 360-574-7294 • fax: 360-574-3834

email: edtsales@edtdcorp.com

www.edtdcorp.com

